

## STEAM HEATING KIT INSTALLATION INSTRUCTIONS MANUAL

### SAFETY INSTRUCTIONS



#### **WARNING!**

##### **INSPECTION, MAINTENANCE OR REPAIR.**

- The installation and/or connection of the heating kits, as well as any intervention that modifies the values of the machine features nameplate must be performed by **AUTHORIZED SERVICE PERSONNEL**, adequately trained by Girbau S.A. or by a Girbau S.A. dealer.
- Likewise, it is the A.S.P.'s responsibility to check that the exterior installation of the washer has been modified and adapted to the new requirements specifically to those regarding electrical conduction and protection.
- Once the corresponding operation has been performed, the dealer's A.S.P. must perform the final machine inspection and update the features nameplate, adapting it to the new conditions.
- The company responsible for the Authorized Service Personnel fully assumes liability for the intervention and any possible consequences that may derive from it.
- Compliance with the safety warnings listed in the Installation Manual is obligatory. Read them before servicing the washer.
- Avoid taking any action on the machine without having first carefully read the washer's installation and operating manuals, paying special attention to the safety instructions.
- Conducting inspections, maintenance or repairs without taking safety measures or having the necessary technical competence can cause **ELECTRICAL SHOCK OR SERIOUS ACCIDENTS**.
- **COMPLETELY** disconnect the washer from the power source and prevent accidental reconnection.
- Disconnect the electrical connection from the external dosing unit on the washer. These circuits are independent of the power supply to the washer.
- Moving the **ON** switch to the OFF position is not sufficient.
- Wait a minimum of five minutes to eliminate the risk of residual voltage.
- Close and mechanically lock the water supply valves and check that the tub has **COMPLETELY** drained, all parts have cooled down and that no parts are moving due to inertia.

### INTRODUCTION.

Any incorporation or modification of the heating systems after the washer has left the plant can substantially change the machine's installation conditions, especially as regards the electrical features.

For this reason, the following steps are very important:

- Request that an authorized installer adapt the washer installation to the new operating conditions: automatic protection switch, electrical conductors...
- Completely disassemble the washer heating system components.
- Install the new heating system KIT paying careful attention to correctly connect and mount the components and electrical conductions.
- Verify that the new heating system operates correctly.
- Assemble and secure ALL the covers and washer protection devices.
- Update the labels and features nameplate.



#### **IMPORTANT**

**CHECK THE NEW INSTALLATION VALUES IN THE TABLE AT THE END OF THE MANUAL.**

**Supplement the following instructions with the diagram and the corresponding parts view of the washer.**

## PRE-INSTALLATION STEPS.

### Disassembly of the existing heating system.

Close and mechanically lock the water inlet valves.

Close and mechanically lock the external automatic protection switch.

Disconnect the electrical supply cables from the switch breaker input terminal on the washer.

Disconnect any possible external dosing signalling connections on the washer.

Remove the back and top covers.

### Machines without a heating system:

Dismantle the housing plug from the left heater (rear view of the machine).

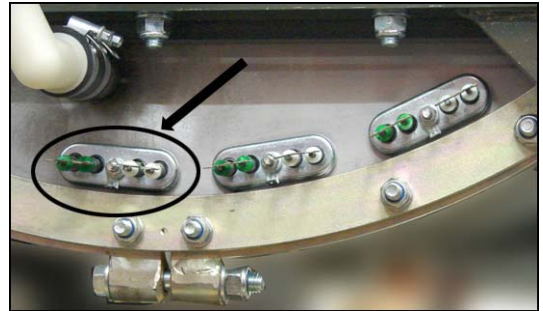

### Machines with electric heating systems:

Disconnect and dismantle the heaters and assemble the right and centre housing plugs (rear view of the machine).

Disconnect the cables for the contactor power circuit **KM1** from the washer switch breaker output terminals and re-connect the rest of the installation.



#### Caution!

When connecting the cables to the switch terminals pay careful attention to:

- Insert all the threads that make up the cable.
- Only insert the uncovered tip. Do not press the cable insulation.
- Tighten the screws ensuring that the cable is firmly fixed.

**Non-compliance with these warnings causes the premature deterioration of the cables and increases the risk of a short circuit.**

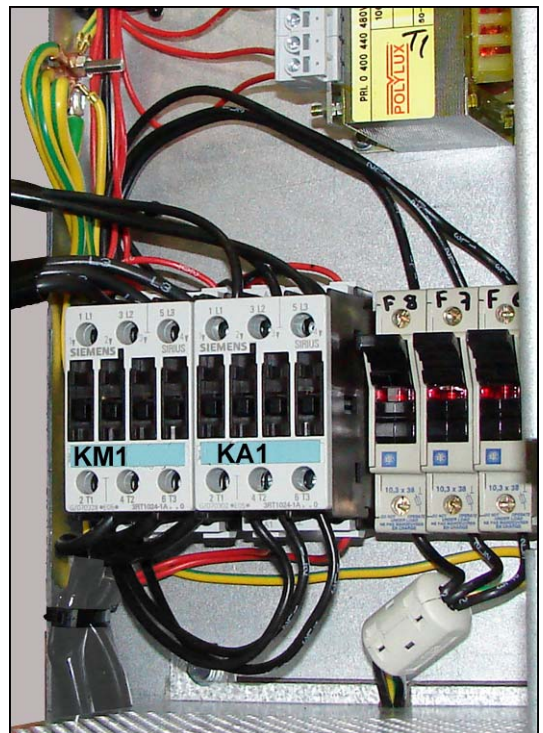

Disconnect the ground cables from the fixing screw.

Disconnect the **KM1** power contactor coil cables from terminal strip **X2**.

Disassemble the mounting clamps and remove the installation.

**KIT ASSEMBLY.**

Fix the steam inlet coupling (C) to the distributor (A). Seal with the copper joint (B).

Fix the distributor to the left housing in the drum.

Fix the steam inlet hose in the coupling joint. Do not tighten the nut (D).

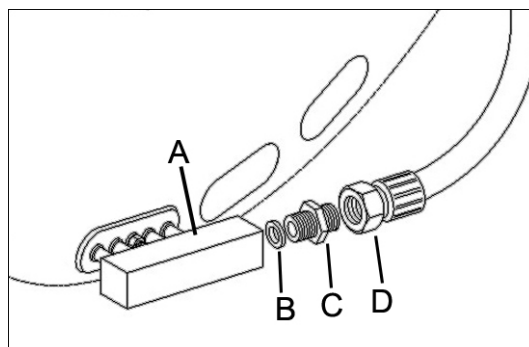
**Caution!**

**For easier assembly, wet the rubber joint on the distributor with soapy water.  
Do not use lubricants.**

The heater must be fixed by the internal clamp in the outer drum.



Fix the steam inlet support (A) to the washer chassis.  
Connect the steam inlet coupling hose (B) to the support.  
Tighten the couplings on both ends of the hose.

Assemble the electro valve (C) and filter (D) using the screw join (E).

Fix them both to the steam inlet support.

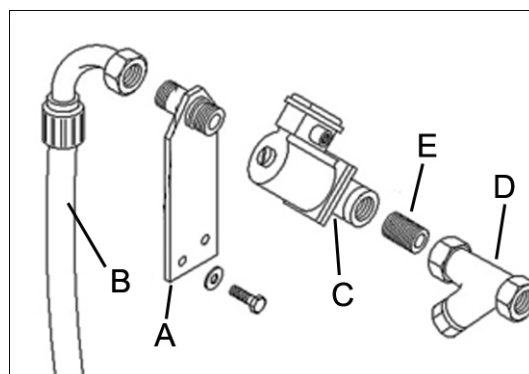
**Caution!**

**Seal the joints with sealing paste that is appropriate for steam pipe conducts.**

Remove the plastic gland from the electrovalve terminal box and secure the wiring with the metal glands supplied with the kit.  
Connect the installation cables to the electrovalve terminals.

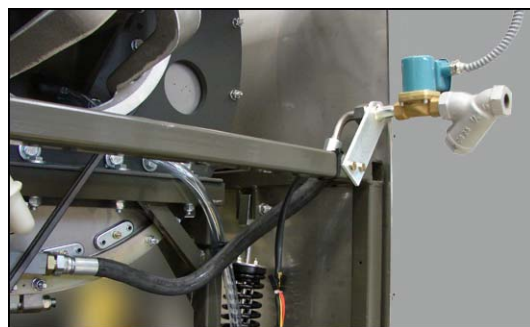

Secure the wiring to the machine avoiding any contact with hot areas or moving parts.

Pass the three power cables through the opening (**Fe**) in the front cover of the washer.

Connect the power coil cables to terminals **3** and **6** on terminal strip **X2**.

This terminal strip is located on the front of the washer, next to the microprocessor board.

Connect the earth cable to the earth screw.

Assemble the top cover of the washer.

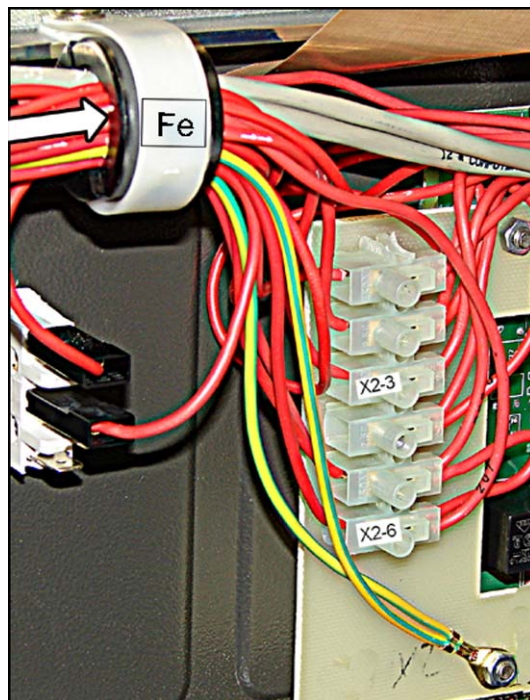

#### CONNECTION TO THE STEAM CIRCUIT ON THE INSTALLATION.



#### CAUTION!

Request that an authorized installer connect the washer to the steam circuit on the installation.

#### Installation features

- Washer B.S.P. steam filter entry thread (inch) 1/2.
- Supply pressure: 2-6kg/h (PSI 29-87 lbs/h)
- Before connecting the installation to the electrovalve, purge the conduit pipes.
- Insert a mechanically lockable manual bypass valve into the steam inlet in an accessible place.
- Safeguard the installation against accidental contact. Insulating the installation to prevent heat loss is recommended.



**VERIFICATION AND FINISHING THE KIT ASSEMBLY.****VERY IMPORTANT!**

**CHECK THAT THE ELECTRICAL INSTALLATION AND THE AUTOMATIC SWITCH HAVE BEEN UPDATED IN COMPLIANCE WITH THE NEW POWER INSTALLED IN THE MACHINE. CHECK THE TABLE AT THE END OF THIS MANUAL.**

**OTHERWISE, DO NOT START THE MACHINE.**

**Verification of the steam circuit watertightness requires operating the washer without the protection of the back cover.**

**For this reason:**

- **TAKE MAXIMUM SAFETY MEASURES**
- **STAY AT A MINIMUM DISTANCE OF 0.5m. FROM THE BACK SIDE OF THE WASHER**
- **NEVER TOUCH ANY INSIDE COMPONENT**

Check that the drainpipe outlet is inserted and secured correctly.  
Connect any possible external dosing signalling connections on the washer.

Connect the electric supply cables to the switch breaker input terminals on the washer.

**VERY IMPORTANT!**

**If the heating kit installation requires a modification to the electrical supply cable, adapt the fastening elements of the new cable in the washer input.**

Connect the external automatic protection switch and the switch breaker.

Open the water inlet valves and the steam circuit inlet valve.

Load the washing machine with linen and close the door.

Run a washing cycle, preferably at a high temperature.

Visually verify the watertightness of the steam pipe conduction threaded unions. **NEVER TOUCH ANY INSIDE WASHER COMPONENT.**

Once the washing cycle is finished, disconnect the external automatic protection switch and close the steam and water inlet valves.

If the test result is satisfactory, assemble and secure all the covers.

**Rear cover assembly**

Cut the pre-drilled points on the back cover and fix the wiring installation in the cover housing using the connector and nut supplied.

Secure the back cover.

Stick the heating label next to the steam valve.



**UPDATING THE CONTENTS OF THE FEATURES NAMEPLATE**

**Model HS-4022.**

An extra features nameplate without values is included in the kit.

Cut on the dotted line and use the fragment in the same language as the features nameplate.

Fill in the empty boxes with a permanent marker.

1. Copy the values from the old plate in the following boxes:

- PHASES
- FREQUENCY
- CONTROL CIRCUIT (V)
- FUSES
- VOLTAGE
- MOTOR POWER

This information does not change when the kit is assembled.

2. Fill in the rest of the boxes according to the values of the attached table.

3. Affix the extra features nameplate with the new values over the current plate.

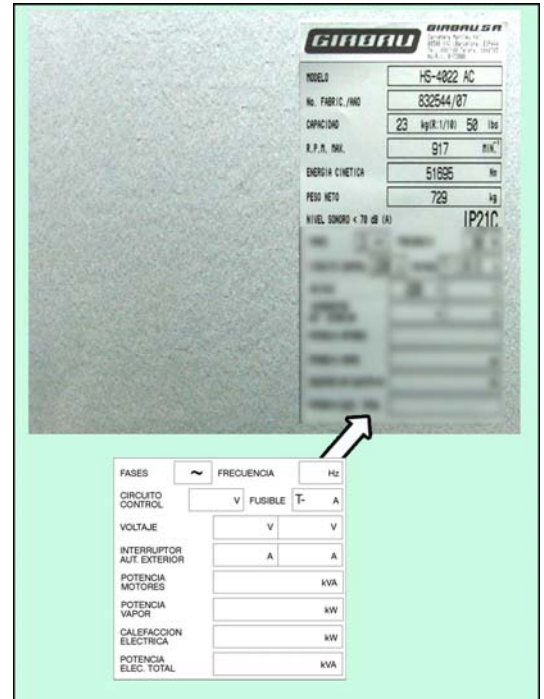

**Electrical wiring technical features table**

Power source:		External automat. switch	Steam power	Total steam power	Cable
Ph	Volts	(A)	(kW)	kVA	(* x mm <sup>2</sup> )
1	200 240	16	60	1.45	2x2.5+ ⊕
3	200 240	10	60	1.8	3x2.5+ ⊕
	380 480	6	60	1.8	3x2.5+ ⊕

**Remarks:**

Cable features:

* x mm <sup>2</sup>	mm <sup>2</sup> *	number of cables section of the cable
---------------------	-------------------	--

**Model H2055.**

An extra features nameplate without values is included in the kit.

Fill in the empty boxes on the extra features nameplate with a permanent marker.

1. Copy the values from the old plate in the following boxes:

- VOLTS (V)
- HERTZ
- PHASE
- NO. OF WIRES
- RATED LOAD (LBS)
- MAX WATER INLET (PSI)

This information does not change when the kit is assembled.

2. Fill in the rest of the boxes according to the values in the attached table.
3. Affix the extra features nameplate with the new values over the current plate.

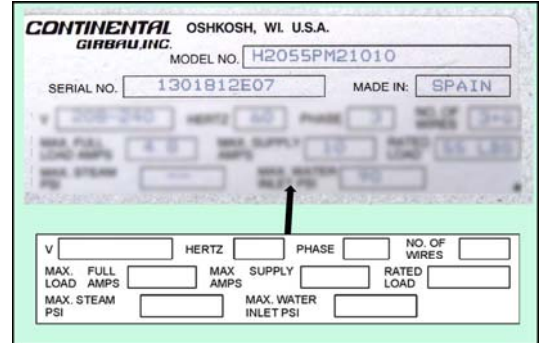

**Electrical wiring technical features table**

Power source:		Max full load	Max supply	Max steam	Wires
Ph	Volts	Amps	Amps	PSI	num x AWG
1	208 240	7	15	90	2 x 14 + GND
3	208 240	4.8	10	90	3 x 14 + GND
	440 480	2.3	6	90	3 x 14 + GND

**Remarks:**

<b>Max. supply</b>	external protection rate (fuse or automatic switch)
--------------------	---